



# Unit - 16

## Effective Planning & Scheduling

### Learning Outcomes

**By the end of this unit the learner will be able to:**

- ✓ Define and create a Work Breakdown Structure
- ✓ Identify and understand task relationships
- ✓ Estimate task durations and determine project duration
- ✓ Construct a network diagram
- ✓ Calculate the critical path of a project
- ✓ Create a communication plan
- ✓ Create a communication plan
- ✓ Effectively allocate project resources
- ✓ Update and monitor the project schedule

# Unit 16

## Introduction to Work Breakdown Structure

### Projects and Schedules

**What is a project?**

---

---

---

---

---

---

---

**Why are schedules so important to projects and to our lives?**

---

---

---

---

---

---

---

**What benefit do they provide?**

---

---

---

---

---

---

---

**Many different factors can affect the planning of a project. What events can affect a project's duration and/or resources?**

---

---

---

Can you think of some events that affected projects or production in general?

---

---

---

---

---

## The Work Breakdown Structure (WBS)

What is a Work Breakdown Structure?

### About the Work Breakdown Structure

A Work Breakdown Structure takes the milestones and breaks them down into the tasks required to reach each milestone. The idea of a Work Breakdown Structure (sometimes called Product Breakdown Structure) is to break larger tasks (milestones) down into smaller tasks (activities) or individual components.

### Sample WBS

Here is an example Work Breakdown Structure for a newsletter project.

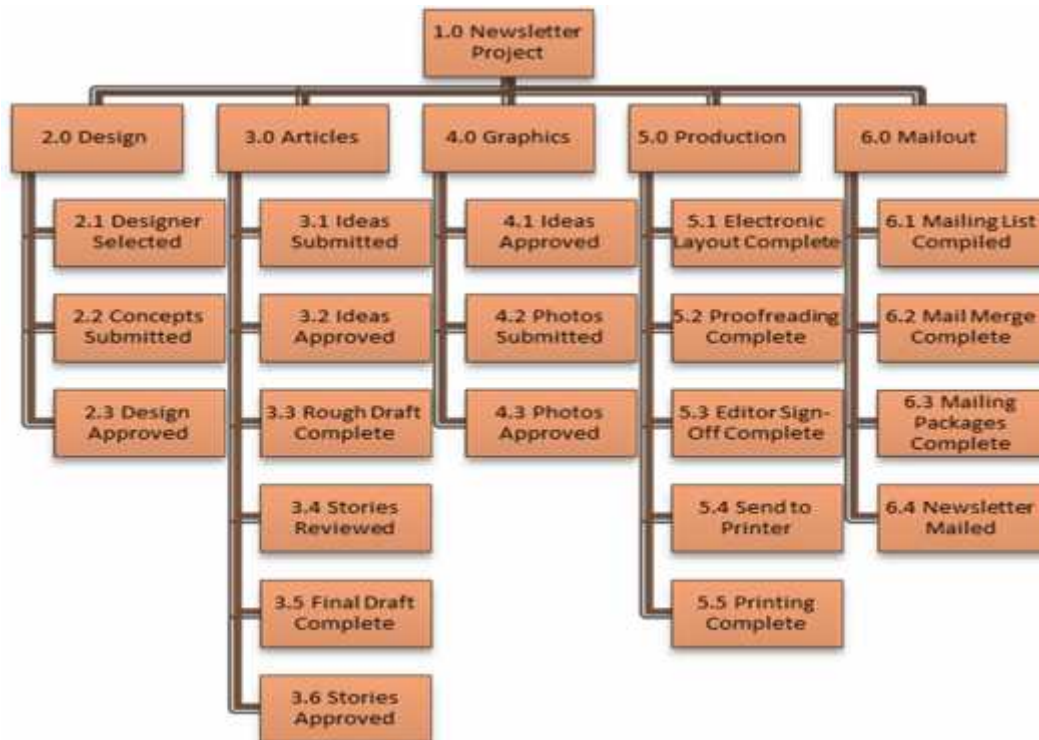

## The Role of a Work Breakdown Structure

When a project begins, it's easy to envision the end goal or deliverable. However, it is not always easy to know how you will get from your current state to the end goal. A work breakdown structure will help you identify the steps and activities required to take you from point A to point B of your project.

Work breakdown structures are a means of breaking down a project into manageable deliverables, activities, or tasks that can be assigned to an owner. For example, consider the project of building a house:

- Ñ How do you make sure the required work gets completed?
- Ñ How do you know what contractor to hire?
- Ñ How do you what kind of house you want to build?
- Ñ How do you know how much it will cost to build the house?
- Ñ How do you even know where to start?

As you can see from the questions listed above, there is no set or clear path on how a project is carried out. Every project is unique in its requirements, duration, and cost. Completing a project is merely working through a pre-determined sequence of milestones/activities that begins with your current state and ends at your final deliverable. A work breakdown structure will help you and your teams identify, organize, and understand the steps required to complete a project. It will also clearly define the project scope.

## Creating a Work Breakdown Structure

### About the Work Breakdown Structure

Work breakdown structures are created from the top down or from the bottom up. If you're working from the top down, the WBS starts with the project as a single event (e.g. Clean Room, Take a Vacation, Move Houses). You start at the project level and work your way down to figure out all of the pieces that must be completed before your project can finish. If you're working from the bottom up, you start with the smallest tasks and work up to the larger tasks.

You can create a WBS with your project team or on your own. Be sure to get a second (or third) opinion on your breakdown if you are unfamiliar with the project and its outputs. Be sure to list all assumptions and criteria used to create your WBS; this will save you time and questions as you progress through the project.

## Steps for Creating the Work Breakdown Structure

### **Step One: Understand the scope and requirements of the project.**

In order to create an accurate WBS, you must first understand all that the project is to encompass. Start this process by going through all documentation you can find (the SOW, RFQ/RFP, etc.) to familiarize yourself with the project scope and criteria, especially if you weren't involved from the beginning.

It is important to remember and make note of the fact that work not indicated on the WBS is out of scope and will not be completed during the project.

### **Step Two: Identify major areas and tasks required to complete the project.**

Once you know the scope of the project, you can then begin to subdivide the project into smaller tasks. Ask yourself, "What has to be done in order to complete this task?" and begin at the project level (Level 1). Write down all of the major components that need to be completed underneath Level 1. The purpose of this step is to get your head around the major events that contribute to project completion.

If your project team is already created, get them involved in this stage of the process, as they are the ones who will be performing the work. They might also have a better idea of the detailed work required to complete each deliverable/task.

### **Step Three: Continue subdividing Level 2 tasks into actionable items and don't worry about order of events.**

Continue to ask yourself the question, "What has to be done in order to complete this task?" to break out the Level 2 tasks. Stop subdividing when you are sure that all tasks under the top level have been accounted for, or until you have reached the desired degree of time measurement (hours, weeks, days, or months).

There is no limit to the number of levels you use in the WBS; some tasks will have many levels underneath, while others might only have one. The lowest level of each branch in the hierarchy is called the work package.

At this point, do not worry about the order in which the tasks must be carried out. Just write down as many activities as you can about milestones/deliverables that need to be completed.

### **Step Four: Draw the WBS in organization chart format or as an indented list.**

There are several ways to create and represent work breakdown structures. There are three different types of structures you can create: deliverable-based, activity-based, or mixed deliverable/activity-based. There are also two different formats for displaying your WBS. The type you use depends on your preferred style and project.

## Types of Work Breakdown Structure Diagrams

**Deliverable-based work breakdown structures** list events and milestones. The events are listed using nouns, like the diagram below.

- 1.0 Room is Clean
  - 1.1 Room is vacuumed
  - 1.2 Room is dusted
  - 1.3 Sheets are washed
  - 1.4 Floor is washed
  - 1.5 Floor is free from debris

**Activity-based work breakdown structures** give specific activities that must be carried out. The activities listed typically begin with verbs, like the diagram below.

- 1.0 Clean Room
  - 1.1 Vacuum
    - 1.1.1 Get vacuum
    - 1.1.2 Plug in vacuum
    - 1.1.3 Turn on vacuum
  - 1.2 Dust
    - 1.2.1 Get duster
  - 1.3 Wash sheets
    - 1.3.1 Strip bed
  - 1.4 Wash floor
    - 1.4.1 Get mop
    - 1.4.2 Get bucket
    - 1.4.3 Fill bucket
  - 1.5 Pick up items off floor

It is possible to mesh deliverable and activity-based **work breakdown structures** together to create a **deliverable/activity-based WBS**. In this instance, some levels of the hierarchy could start with nouns, while others could start with verbs, like the diagram below.

## 1.0 Clean Room

- 1.1 Room is vacuumed
  - 1.1.1 Get vacuum
  - 1.1.2 Plug in vacuum
  - 1.1.3 Turn on vacuum
- 1.2 Room is dusted
  - 1.2.1 Get duster
- 1.3 Sheets are washed
  - 1.3.1 Strip bed
- 1.4 Floor is washed
  - 1.4.1 Get mop
  - 1.4.2 Get bucket
  - 1.4.3 Fill bucket
- 1.5 Floor is free from debris

### Work Breakdown Structure Formats

You can use any combination of the formats below to create your work breakdown structure. Choose the best format for your project and organization and stick with it for the duration of the project.

#### Indented List

Level 1	Level 2	Level 3
Project	Task 1	
		Work Package
		Work Package
		Work Package
	Task 2	
		Work Package
		Work Package
	Work Package	

## Spreadsheet

Work Breakdown Structure										
Project					Project #					
Project manager					Version					
Project start date					Updated					
ID	Task	Dependencies	Status	Est. Hours	Cost	Start Date	Percent Completion	Estimate to Completion	Actual Completion	Resource
1		10 h of work								
2										
3										
4										
5										
6										
7										
8										
9										
10										

## Organizational Chart



## Work Breakdown Structure Numbering

When creating a WBS, it is good form to number each level and milestone/activity. This will allow anyone involved with the project to refer to a specific task or event at any time.

The project itself is considered Level 1. As you subdivide events, each division creates another level of depth to the structure. As you describe and break out project components in more detail, you are creating levels 2, 3, 4, and so on.

There is no required or standard number of levels in a WBS; the only rule is to go down as far as necessary to reach your desired measurement unit or until you cannot subdivide any further. The table below shows standard numbering for a work breakdown structure.

Level 1	Level 2	Level 3
1.0 Project	1.1 Task 1	
		1.1.1 Work Package
		1.1.2 Work Package
		1.1.3 Work Package
	1.2 Task 2	
		1.2.1 Work Package
		1.2.2 Work Package
	1.3 Work Package	

### Work Breakdown Structure Dictionary

A Work Breakdown Structure dictionary is sometimes helpful if the WBS content is not self-explanatory or is very complex. The level of detail in a WBS dictionary is basic, but it does provide more information for those stakeholders/team members who may not be aware of the finite details.

The WBS dictionary can take on whatever format you like, from a formatted document to a compilation of completed templates. That being said, there are a few general rules that you should be aware of when creating a dictionary. The dictionary should:

- Ñ Identify the hierarchical relationship of the element
- Ñ State specifically what is involved with the task or activity
- Ñ List any pertinent technical documentation, assumptions, or factors considered
- Ñ List known resources or processes required

Below are a sample Work Breakdown Structure and Work Breakdown Structure dictionary. To create and complete a WBS Dictionary, follow the sample below, listing the activity number, activity name, and a description for what is involved with the task.

**Work Breakdown Structure**

1.0 Room is Clean
1.1 Room is vacuumed
1.2 Room is dusted
1.3 Sheets are washed
1.4 Floor is washed
1.5 Floor is free from debris

**Work Breakdown Structure Dictionary**

WBS Dictionary			
Project		Project #	
Project manager		Sponsor	
Project artifacts		Updated	
Activity Number	Activity Name	Description	
e.g. 1.3	Sheets are washed	Sheets are to be removed from bed, washed, dried and placed back on bed	

**Work Breakdown Structure Exercise**

Create a WBS for taking a camping trip.

Level 1	Level 2	Level 3	Level 4



the type and quality of the estimate you provide is directly related to the information you have and are able to receive.

The main thing to remember when putting together an estimate, regardless of how preliminary, is to list all assumptions and factors that you considered. Listing your assumptions and factors lets the reviewer know what your calculations were based on, and also provides a base for estimate comparison.

### Sample Spreadsheet

Below is a sample assumption and constraints spreadsheet.

Assumptions and Constraints					
Project			Project #		
Project manager			Sponsor	U	
Project artifacts			Updated		
ID	Description	Comments	Type	Status	Date Entered
1					
2					
3					
4					
5					
6					

### Gathering Resources

Estimating is not exact; it is a guess. If you or someone on your project team has completed a similar task before, then you should have a better idea of how long it will take to complete the task. It does not, however, guarantee that the estimate will be exact. However, if the project is new, you might have trouble finding someone who can advise you on how long a task will take to complete.

The more people who help you estimate, the better. This will allow you to generate an average expected completion time for tasks. Asking three different people for the time per activity is one way to get a good average.

As the project progresses, be sure to maintain a log of actual completion times for each task. This will enable results to be used as reference on future projects. Also, make special notes on where your estimations were well under and over.

### Activity List

Once you know all of the activities involved with a task, you are able to estimate how long it will take to complete the activities, and thus roll up the estimation to the event level.

Since the WBS determines the unit by which you will provide estimates (months, days, hours, or minutes), be consistent when assigning durations to activities. All activities should have the same time unit.

### Resources

There are three types of resources that you can have on your project team: full-time, part-time and consultant.

- Ñ Full-time resources can be internal or external to your business and are dedicated to your project and at your disposal 100% of the time.
- Ñ Part-time resources are internal or external people who have full-time jobs, but are taking on project work in addition to their daily responsibilities. They are the resources who make up the majority of project teams.
- Ñ Consultants are specialists who are brought in for their expertise on specific projects and subject matter. Depending on the contract you have with them, they can be either full- or part-time resources.

Resource availability needs to factor into your estimates. For example, let's say that a software investigation is estimated to take five days to complete and your software expert is only available 50% of the time. Although the full-time employee could complete the task in one week (five consecutive days), the part-time resource needs two weeks (ten consecutive days) to complete the same task. The actual time it takes to complete the task hasn't changed, but the overall elapsed time is twice as long.

As a general rule, resources underestimate activity durations. They tend to overlook factors such as sick time, vacation, and personal fatigue and delay (PFD) when providing duration estimates. Although someone may be at work for eight hours a day, when considering PFD (washroom breaks, personal breaks, mealtimes, and fatigue), they are only truly available for about 6.8 hours a day ( $8 \text{ hours} - (8 \text{ hours} * 15\%) = 6.8 \text{ hours}$ ). Keep this in mind when estimating task durations.

### Tips for Increasing Estimation Accuracy

**Document all of the assumptions and factors that went into creating the estimate.** This will allow anyone who views the estimate to be aware of how the number was reached and provides a baseline for the estimate.

**If the project is large, complex, or completely new, ensure you allow ample time up front for requirements gathering and the estimating process.** If there are no experts whom you can ask for help, you will be stuck figuring it out on your own, so allow enough time to work through these stages.

**Set up contingency plans** for critical path items, unanticipated events, and risk. The more you know about potential risks that can affect critical path items, the better. This will help you manage your timelines and estimates up front. (We'll talk about these kinds of events later on in the course.)

**Involve as many people as you can in estimating activity durations.** Between you, experts, and your resource team, everyone should be happy with and agree upon the time it takes to complete the activities. The more people involved in the estimating process, the more accurate your estimates will be.

**Create an activity list from the WBS and follow it.** Once the WBS is complete, and the project is disaggregated into manageable chunks, you can create an activity list that describes each of the tasks that need to be completed during the project. The activity list should include all of the required activities, assumptions, restrictions for each activity, along with the assigned resource. The WBS activity list encompasses the scope of your project and will ensure all tasks are included on the project schedule.

**Be aware that people often underestimate activity durations.** Underestimation isn't done intentionally; people just tend to think it will take less time to complete their tasks than it actually does.

**Track actual completion times for all projects and tasks.** This will allow you to see how accurate your estimates are, and will prove to be an invaluable resource if a similar project arises again.

**Be aware of the time of year** during which your project will be carried out. From illnesses during back-to-school and Christmas vacation, to summer vacations, there are certain times every year that will almost guarantee resources will be out of the office and unavailable to you. Make sure you pay attention to this and that your estimates reflect the seasonal highs and lows of your resource pool.

If **training** is a prerequisite for learning appropriate project skills, be sure to include the time for training in your task estimate.

## Camping Case Study

Fill out the chart in below with the work breakdown structure a camping trip. Then, go through each task and assign durations (in hours) to each activity. Finally, roll up the activity durations to the event level and then to the project level.

Level 1		Level 2		Level 3		Level 4	
Task	Duration	Task	Duration	Task	Duration	Task	Duration



Task 1 needs to be complete before Task 2 can start, and Task 4 can't start until Task 3 is finished. This example illustrates that all projects have task dependencies, even if the dependencies are intuitive. Similar to the example just described, workplace projects have tasks that are dependent on one another.

In order to establish the interrelationships between tasks, here are a few helpful questions you can ask yourself:

- Ñ What precedes this task? (What other tasks must be completed before this one can get started?)
- Ñ What tasks follow this task? (What tasks can't be started until this task is done?)
- Ñ What tasks can take place concurrently with or in parallel to this one? (What tasks can be worked on while this is being completed?)

### Dependency Definitions

A **predecessor** is a task/activity that precedes another task/activity. (A must be complete before B can begin, thus A is a predecessor to B.)

A **successor** is a task/activity that must follow another task/activity. (In the example above, B is a successor to A.)

**Series tasks** are tasks that happen one after the other. (For example, you get engaged before you get married.)

**Parallel tasks** are tasks that can happen simultaneously. (For example, you can research vendors for a software solution at the same time as you are working to determine your budget.)

**Sequencing** is the order in which activities are to be carried out. It considers predecessors, successors, series, and parallel tasks.

**Lead time** is when one task gets a head start. (For example, a new server is required for a software project that is about to start. The project manager knows it will take three weeks for the server to arrive, so a lead time of three weeks will be worked into the duration of the task.)

**Lag time** represents a delay between tasks. (If you have the tasks "pour concrete" and "frame house," you need to add a lag time of a few days to the "pour concrete" task to ensure the concrete is dry prior to framing the house.)

### Task Dependency Types

The four types of task dependencies are: start-to-start (SS), finish-to-start (FS), start-to-finish (SF), and finish-to-finish (FF).

**SS: Start-to-Start**

Tasks can run in parallel, but Task B can't start until Task A has started. For example, if Task A is "Watch television" and Task B is "Change channels," it's obvious that you can't "Change channels" until you're watching television.

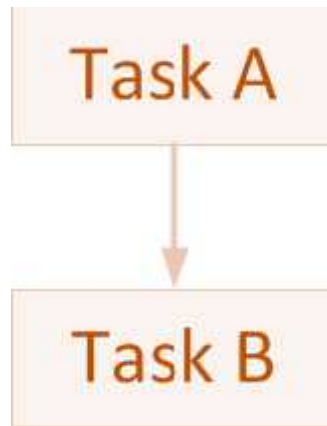
**FS: Finish-to-Start**

Task B can't start until Task A has finished. For example, let's say that Task A is "Hang drywall," and task B is "Paint drywall." "Paint drywall" can't start until "hang drywall" is complete.

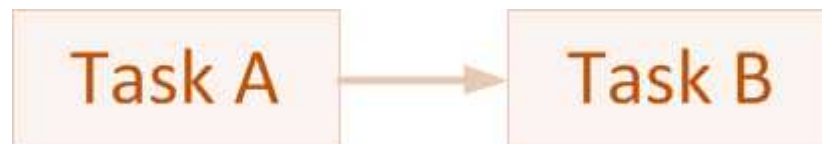
**SF: Start-to-Finish**

Task B can't finish until Task A has started. Consider a 24/7 production environment; in order to maintain constant flow within the facility, Shift B can't finish until Shift A arrives and receives the hand-off.

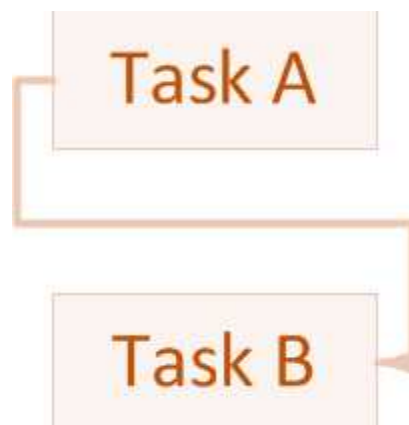

**FF: Finish to Finish**

Task B can't finish until Task A has finished. For example, Task B, "Software test report," cannot finish before Task A, "Software testing," finishes.

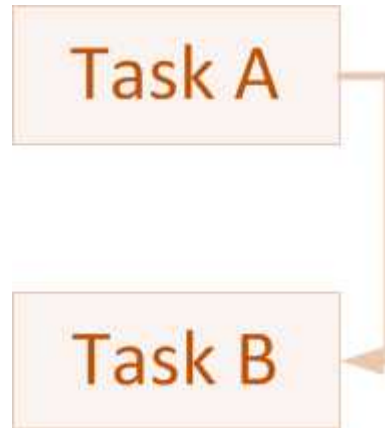
**Case Study: Trip to New York**

You and a friend are planning a weekend trip to New York. It is up to you to ensure each task gets completed in the correct order.

**First, put these activities into the proper sequence by numbering them.**

- Ñ Book flight
- Ñ Research hotels
- Ñ Trip to New York (project)
- Ñ Research restaurants
- Ñ Go to airport
- Ñ Plan activities
- Ñ Book hotel
- Ñ Book car
- Ñ Pack suitcases
- Ñ Determine budget
- Ñ Select dates
- Ñ Renew passports
- Ñ Talk to travel agent





Resource Breakdown Structures (RBS) graphically display, in organization chart format, the resource requirements for the entire project. They are a helpful tool because they force the project manager to look at each phase and consider the resources that need to be involved to get the task complete. Once the project team is finalized, resource breakdown structures provide a high-level breakdown of the resources involved with the project.

### Sample Resource Breakdown Structure

Below is a sample RBS as created for a new product introduction (NPI) project.

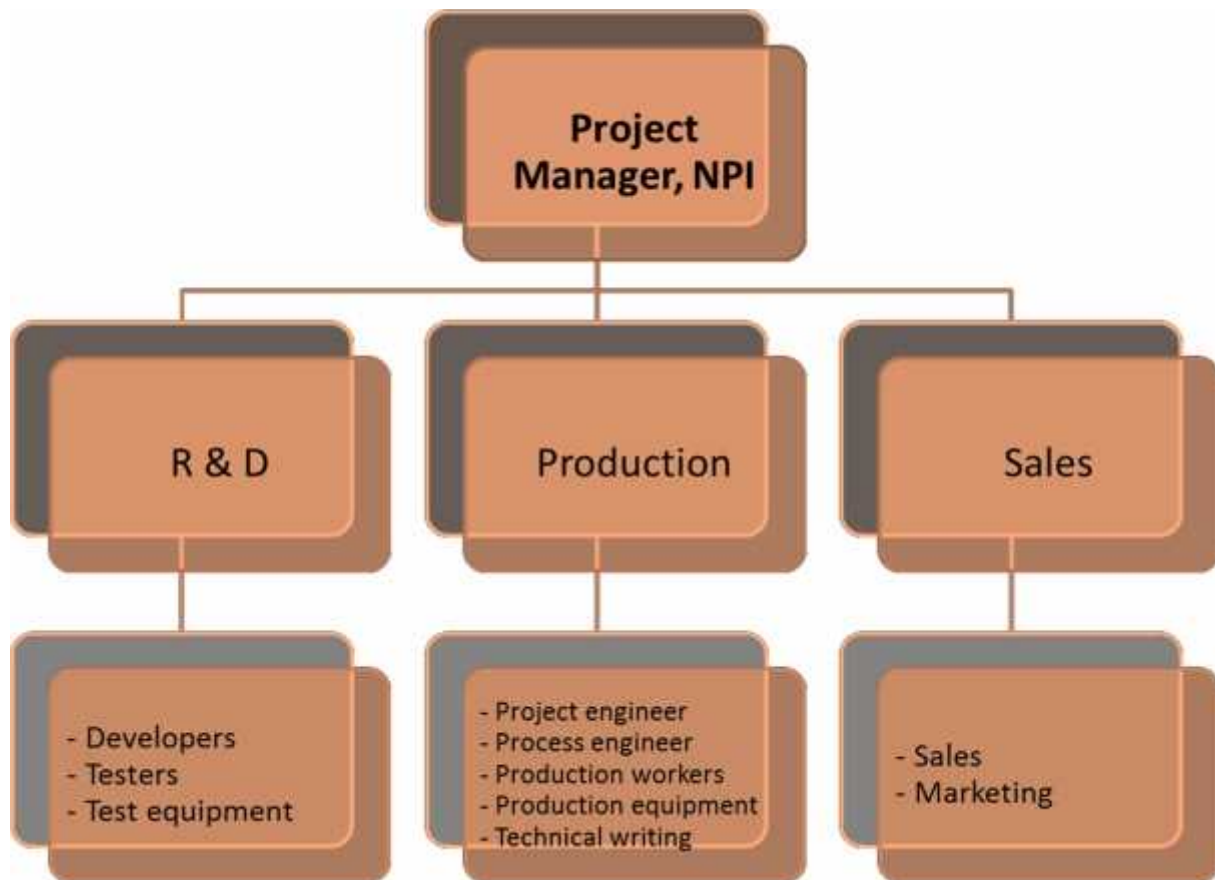

### Creating the Resource Breakdown Structure

If the resources are known at the beginning of the project, list names and information in the RBS. Otherwise, it is okay to initially list teams and departments. Reduce the teams and departments to the lowest level you can. Once resources are determined, update the RBS chart by adding the names of required personnel and equipment.

### Availability and Skills

Resources volunteer, are assigned, or are nominated for projects. A sponsor might select the project team, people with an interest in the work might volunteer for the team, or people who care about the project outcome might nominate a colleague in whom they have confidence to get the job done.

Regardless of how project teams are formed, there are two things every project manager needs to know about each resource: their availability and their skill set. Without this knowledge, you will not be able to accurately plan the project or assign appropriate resources to activities.

The time a resource is able to dedicate to your project is of the utmost importance. If a resource is only available 50% of the time and you have them assigned to work that requires 100% of their time, you're going to have a problem meeting your schedule.

When determining resource availability, you must also consider the personal fatigue and delay (PFD) factor we discussed during "Estimating Activity Durations." The PFD factor accounts for personal breaks, fatigue as we get tired, and delays due to waiting for information, computers, etc. PFD accounts for 15 to 20 percent of everyone's work day. If a task is scheduled to take eight actual working hours to complete, do not assign it to a resource and expect that it will be completed in one working day. With PFD factored into an eight-hour workday, there are only 6.8 actual working hours in one day. This means that the most one resource would be able to accomplish is 6.8 hours of estimated work.

If your project team is not predetermined, use your resource breakdown structure to help you select departments and fill personnel requirements. Solicit each department for resources that have the experience you're looking for. The manager of the department will need to know your weekly time commitment for each resource, so be sure to have an idea of what tasks the person will be assigned.

When project teams have already been formed, knowing the skill set for each of your resources is critical. Each resource should be assigned to tasks within their department, their role, and most importantly, their competence level. Once you know the skill required to complete the task, assign an appropriate resource. Be aware of task relationships and critical path items as you assign resources to tasks.

If you have a resource requirement that you cannot fill with resources already assigned to your project, you must address it immediately. You could ask for additional resources, recommend training, or you could make a case for bringing in an experienced consultant for the duration of the project. Whatever route you deem necessary, it is crucial that you address all resource shortcomings up front and that you build a pool of resources that can complete the project.

Resources should be assigned to a project in an economical way; they shouldn't be sitting idle 50% of the time and they shouldn't be expected to work 150% of the time. There is a fine balance between keeping resources busy and overwhelming them with tasks.

### **Resource Calendars**

A resource calendar is a useful method of tracking resource availability. The resource calendar provides a list of working time and non-working time for people, equipment, and materials. Resource calendars contain information such as shift times, vacations, holidays, preventative maintenance downtime, and

production shutdowns. A resource calendar may also prove beneficial to other project managers if you plan to share resources across multiple projects.

You can build resource calendars in most scheduling software programs. However, if you are not using scheduling software to create a schedule, you can create a basic calendar using Excel or Word. Be sure to include vacation, downtimes, course time, shift information, and working time in your calendar.

### **Stages of Resource Scheduling**

There are four stages of resource scheduling:

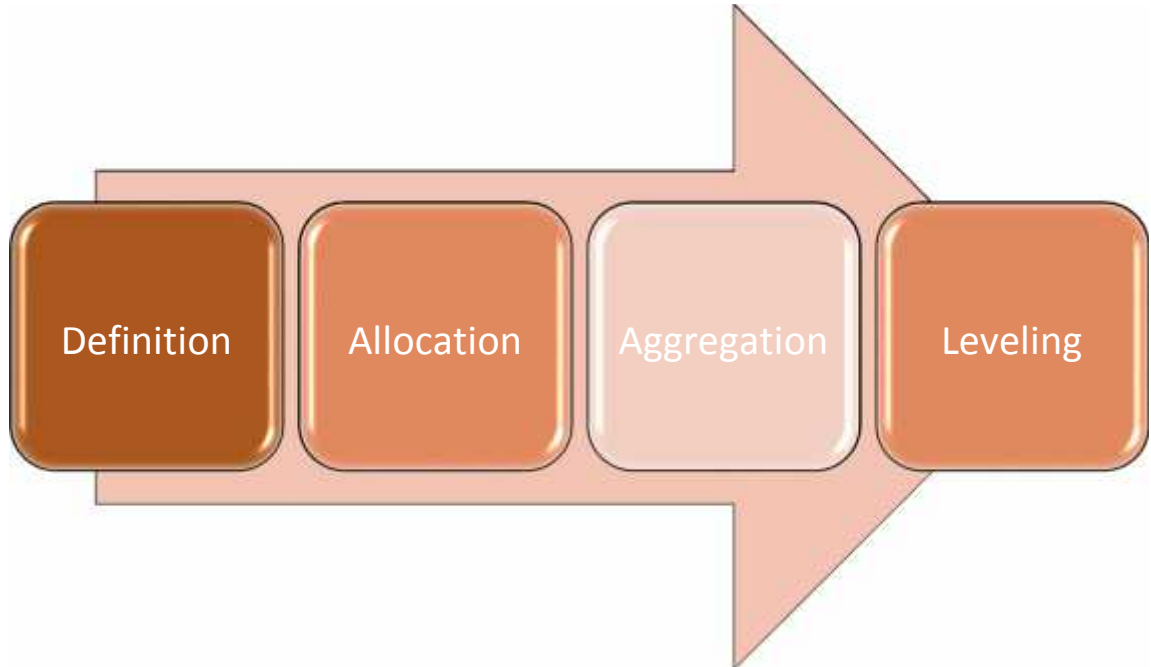

#### **Definition**

This stage in the resource scheduling process is to determine and define the resources that will be modeled in the schedule. As previously mentioned, resources can include people, material, space in a facility, etc. If you anticipate that you might be constrained on any one resource, it is important to model it when you perform resource scheduling.

#### **Allocation**

Resource allocation is when the resources identified in the definition stage are assigned to each task/activity in your project plan. The number of resources required for each activity should be identified. Multiple resources of different types can be assigned to any activity. At this point, don't worry about the impact that assigning (or not assigning) resources will have on your project plan. The impact will be assessed during the leveling stage of the resource scheduling process.

#### **Aggregation**

Resource aggregation is the summation of all required resources during a set interval of time (hours, days, months, etc.). Resource aggregation is a technique that helps identify how efficiently resources are

being used. Once you've completed resource aggregation, you can perform resource leveling to properly balance resource utilization.

### **Leveling**

Resource leveling is the process of examining the balance of required resources against actual resources over the duration of a project. Leveling helps prevent over (and under) allocation of resources. If the number of resources required never exceeds the availability, you do not have a resource issue.

However, if your demand exceeds your actual available resources, you can start the leveling process by looking at your highest resource demand to see if it's possible to reduce the number of resources required during the given time period.

- Ñ Are there any tasks can be performed in parallel?
- Ñ Is there float on tasks that you can leverage (i.e. start early or start late) to free up resources at alternate times?

Keep in mind that the goal of this step is to smooth resources so you aren't overworking some resources while others sit idle.

Resource leveling is not simple. There are two considerations that need to be addressed when leveling resources: time constraints and resource constraints.

### **Time-Constrained Project**

If you have a mandated completion date for your project, emphasis needs to be placed on completing the project by a specific date. You may need to negotiate for additional resources or overtime, which will add additional cost to the project. If reducing the scope of the project is an option, you might want to look into this. You can also look at the float for non-critical path tasks to see if you can adjust the start/finish time.

### **Resource-Constrained Project**

If you have a limited number of resources, emphasis needs to be placed on finishing the project with the given resources. You can only move the resources around so much before the critical path is affected and the end date of the project is altered. Another option would be to look into the float available to tasks that aren't on the critical path. Can a resource conflict be resolved by starting a task earlier or finishing it later?

As you can see, there are several options that will need to be considered as you step through resource leveling. There is no one right answer, as every project has different requirements.

## Resource Turnover

Resources can come and go throughout the duration of a project. You will add new project members as the project evolves and you will lose members as phases and tasks get completed, or as other duties take precedence. Be aware that the dynamics of the project team will likely change as members join and leave the team. It often takes teams some time to develop a rapport with one another, to effectively make decisions, and to get to know the ins and outs of the project. As resources leave, they take project knowledge with them, leaving the new team member back at the starting gate. It is the remaining members who must orient the new member and help them gain the background they need. Due to the disruption in flow and cohesiveness, you should try to minimize resource turnover whenever possible.

## Case Study: Planning an Outdoor Concert

This case study will consider the project of planning an outdoor concert and the resource requirements you will need to have a successful event.

### Review this sample Work Breakdown Structure.

1. Planning an Outdoor Concert
  - 1.1. Site
    - 1.1.1. Selection
    - 1.1.2. Council
    - 1.1.3. Environment
    - 1.1.4. Neighbors
    - 1.1.5. Clearing and Cleaning
    - 1.1.6. Handover
  - 1.2. Promotion
    - 1.2.1. Print
    - 1.2.2. Radio
    - 1.2.3. Television
    - 1.2.4. Clubs
    - 1.2.5. Internet
    - 1.2.6. Other
  - 1.3. Finance
    - 1.3.1. Sponsorship
    - 1.3.2. Grants
    - 1.3.3. Accountants
    - 1.3.4. Tickets
    - 1.3.5. Budget
    - 1.3.6. Audit and Report
  - 1.4. Human Resources
    - 1.4.1. Planning team
    - 1.4.2. Concert team
    - 1.4.3. Security
    - 1.4.4. Tickets
  - 1.5. Entertainment
    - 1.5.1. Selection
  - 1.6. Amenities
    - 1.6.1. Food
    - 1.6.2. Washrooms
    - 1.6.3. VIP Seats





## Effective Project Planning

### Network Diagrams

#### Types of Network Diagrams

Network diagrams are drawings that display activities, their associated precedence relationships, and the order (series or parallel) in which the tasks can be completed. The precedence relationships are illustrated by the use of nodes and arrows.

There are two different kinds of network diagrams: activity on node (AoN) and activity on arrow (AoA).

#### About Activity on Node Diagrams

Activity on Node diagrams place the importance on the tasks by displaying the activity on the node. Tasks are represented by boxes while the arrows show the task dependency. With the AoN diagram, the node is used to house information about the task.

A rounded edge rectangle shows the start and end points of the diagram. This represents time zero.



A rectangle represents the activities.

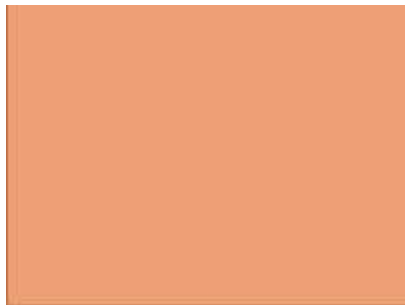

A solid arrow shows precedence between tasks.



## Sample Activity on Node Diagram

The table below describes activities and task relationships for a project.

Activity	Predecessor
A	None
B	None
C	A
D	B, C
E	D
F	D, E

Below is the network diagram for the above table.

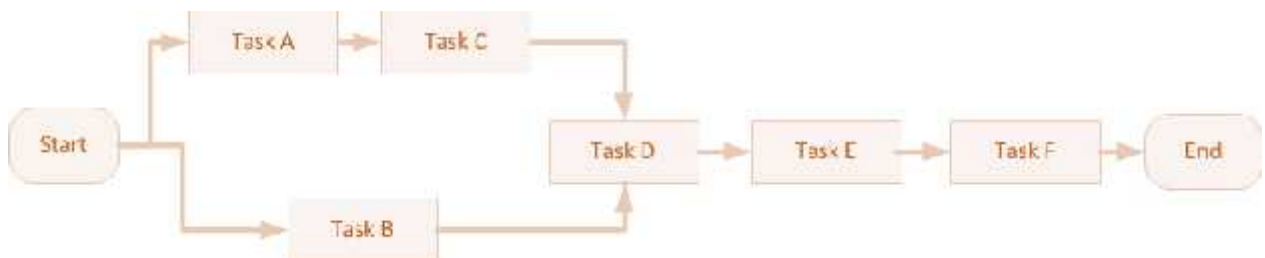

## About Activity on Arrow Diagrams

Activity on arrow diagrams place importance on milestones. When constructing an activity on arrow diagram, all tasks lead to nodes (milestones). The tail of an arrow is the start of the activity, and the head of the arrow is the completion of the activity. Tasks are written on top of or below the solid arrows. At the start node of AoA diagrams, the time is always zero.

A circle represents a node (milestone) and is used to show the connection between activities. The starting node is always time zero.

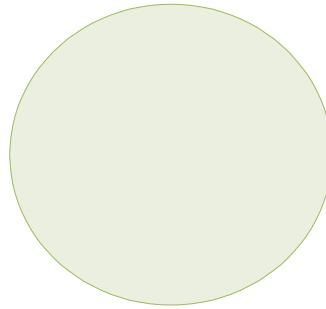

A solid arrow represents an activity.



A dashed arrow represents a dummy activity. Dummy activities are used to show precedence relationships and have a duration of zero (0). Dummy activities are only used in AoA diagrams.



In AoA diagrams the nodes are typically numbered, but this number does not indicate precedence or duration. Activities are usually written as a letter, such as A, B, or C, because there is limited space available above/below the arrows for each written task description.

### Sample Activity on Arrow Diagram

The table below describes activities and task relationships for another example project.

Activity	Predecessor
A	None
B	A
C	None
D	B
E	C
F	D

G	B, E
H	F

Below is the network diagram for the above table.

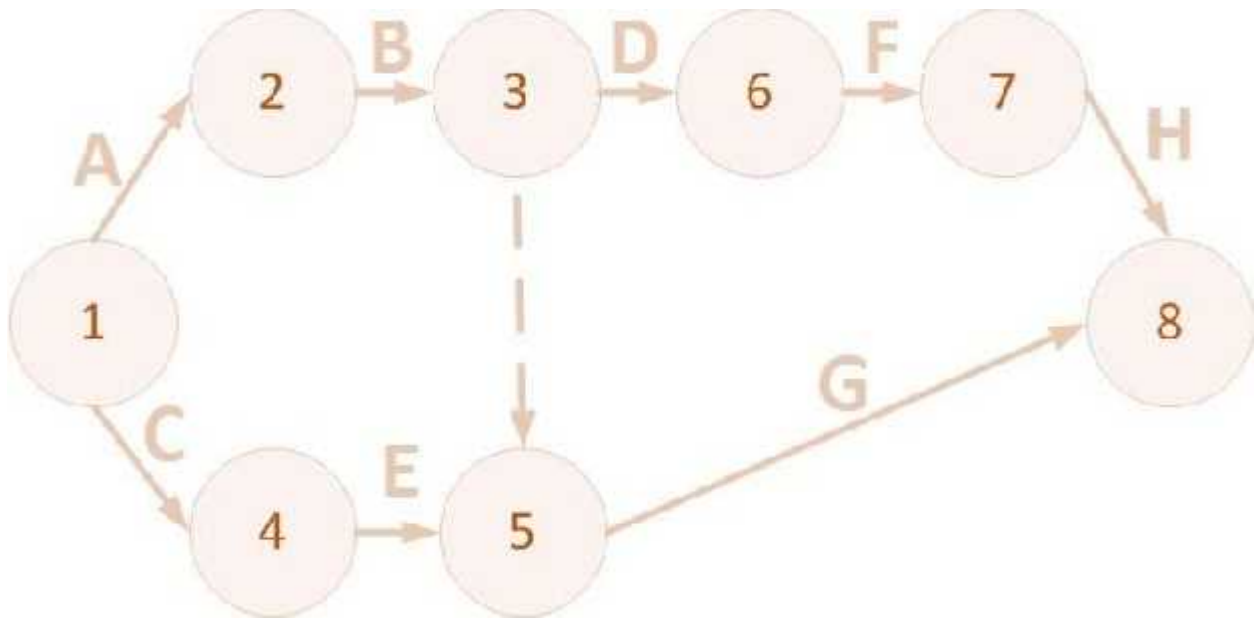

## Critical Path Method

### What is the Critical Path Method?

The term “critical path” is very important in the world of project management. A critical path identifies the total duration of a project and identifies the tasks that must be completed, in order and on time, to complete the project on schedule.

CPM is a systematic approach to finding the critical path of a project. It uses the work breakdown structure to create network diagrams and is calculated by examining task relationships, activity durations, and activities.

An activity is said to be on the critical path if there is no slack to push the activity date out without affecting the overall duration of the project. Slack is the amount of time an activity can be delayed before the overall duration of the project is delayed.

Once a project is represented by a network diagram, the critical path can be found. For smaller projects, you will sometimes be able to quickly identify the critical path from the network diagram. However, for

larger projects it would be impossible to determine the critical path by looking at the network diagram. Once you have activities, task relationships, and time estimates, you are ready to create your CPM network diagram.

## Sample Project

We will now walk through an example using the critical path method and the project listed below.

- Ñ A and B are performed concurrently at the start of the project
- Ñ C can begin on the completion of A
- Ñ F is completed in parallel to D, upon B's completion
- Ñ D follows B
- Ñ C precedes E
- Ñ G can begin when D and F are complete, and marks the end of the project

The estimates for the activity durations are as follows.

- Ñ A: 8 days
- Ñ B: 20 days
- Ñ C: 18 days
- Ñ D: 23 days
- Ñ E: 9 days
- Ñ F: 10 days
- Ñ G: 4 days

## Creating a Network Diagram

When creating network diagrams to perform CPM, you must include more detail at the node level. Below is a sample CPM node that shows the layout and description for each required field.

ES		EF
Activity, Duration		
LS	SL	LF

Where:

- Ñ ES = Earliest Start, the earliest time that this activity will begin
- Ñ EF = Earliest Finish, the earliest point at which this activity will end
- Ñ LS = Latest Start, the latest time that this activity will begin

- Ñ LF = Latest Finish, the latest point at which this activity will end
- Ñ SL = Slack, the amount of delay available for an activity

## Starting Network Diagram

Here is the network diagram for the project listed above. As you can see, all precedence relationships have been identified, and the activities and durations are labeled.

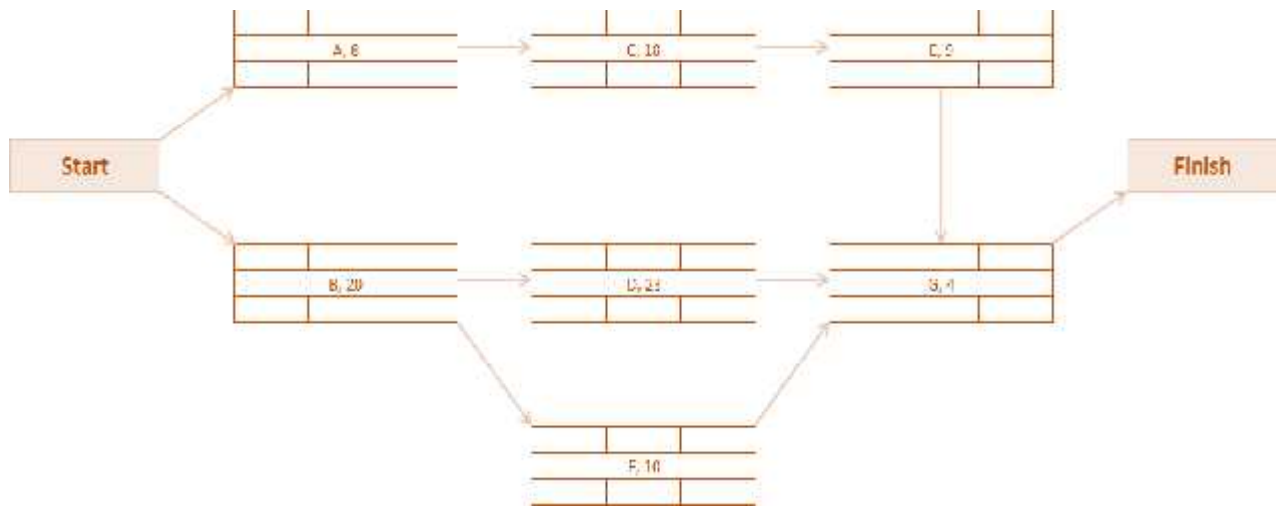

## Perform Forward Pass through Network

The forward pass through the network provides details on the earliest start and finish times for each activity. Start with the first activity (or activities) and step through each activity on each path of the network. The start node is always time zero. Successive tasks begin as soon as their predecessor(s) are complete. If two or more arrows enter one node, you must use the highest completion time for the previous task. This means that if one task finishes at 12 days and the other at 17 days, you would use 17 days as the starting point in the next node.

Now we'll step through the forward pass. An updated network diagram is below and depicts the results of the forward pass.

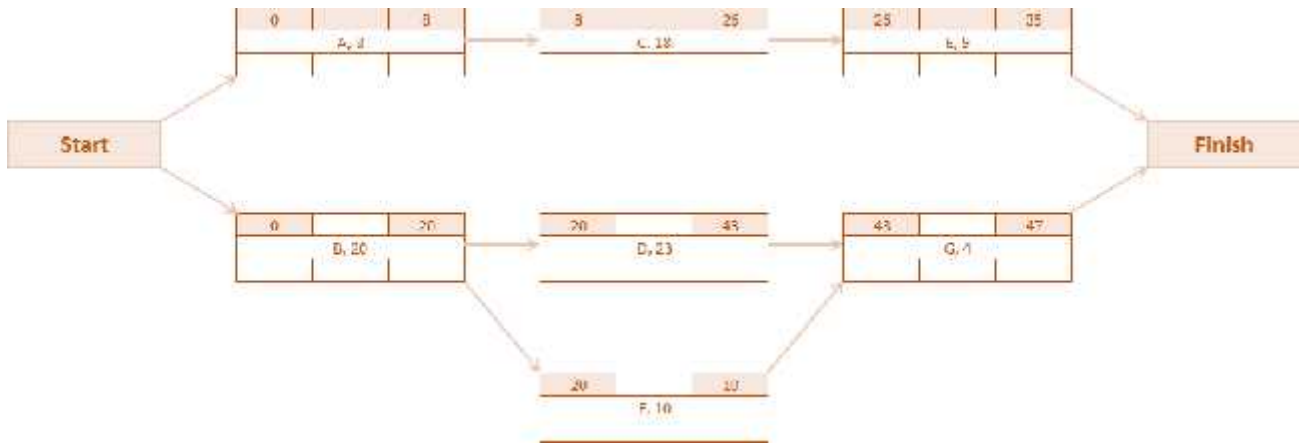

The total duration of the project will be 47 days – the longer of the last two tasks.

## Perform Backward Pass through Network

The backward pass through the network provides details on the latest start and latest finish times for each activity. The backward pass method through the network is identical to the forward pass, except instead of working from the front to the back through the diagram, you will now work from the back to the front.

The ending point (latest finish) for the backward pass is the earliest finish time of the final activity, G in our example, which was 47 days. The latest finish time for an activity is the latest start time of its successor. If two arrows lead to one activity, the latest finish for that task is the smaller of the latest start times of each successor.

The earliest finish for our example at activity G is 47. Plug the number 47 in for the latest finish time and begin the backward pass.

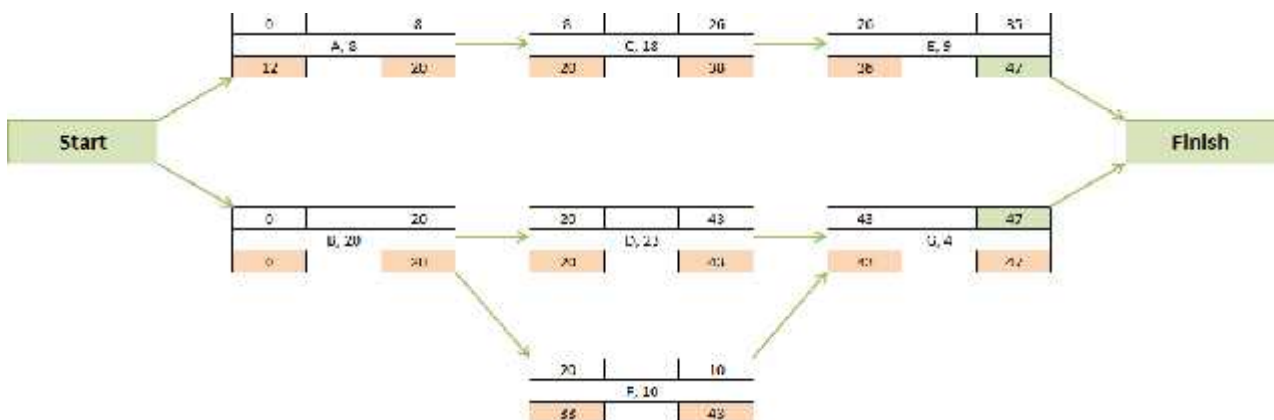

## Determine Slack

Now, determine the slack associated with each activity by subtracting the earliest start time from the latest start time, or the earliest finish time from the latest finish time. The network diagram is now populated with slack, as seen below.

When slack exists in an activity, it means there is extra time available in the schedule during which you can complete said activity. For example, task E above has a slack of nine days. Task E can therefore start anytime between time 26 and time 47, and still be on time.

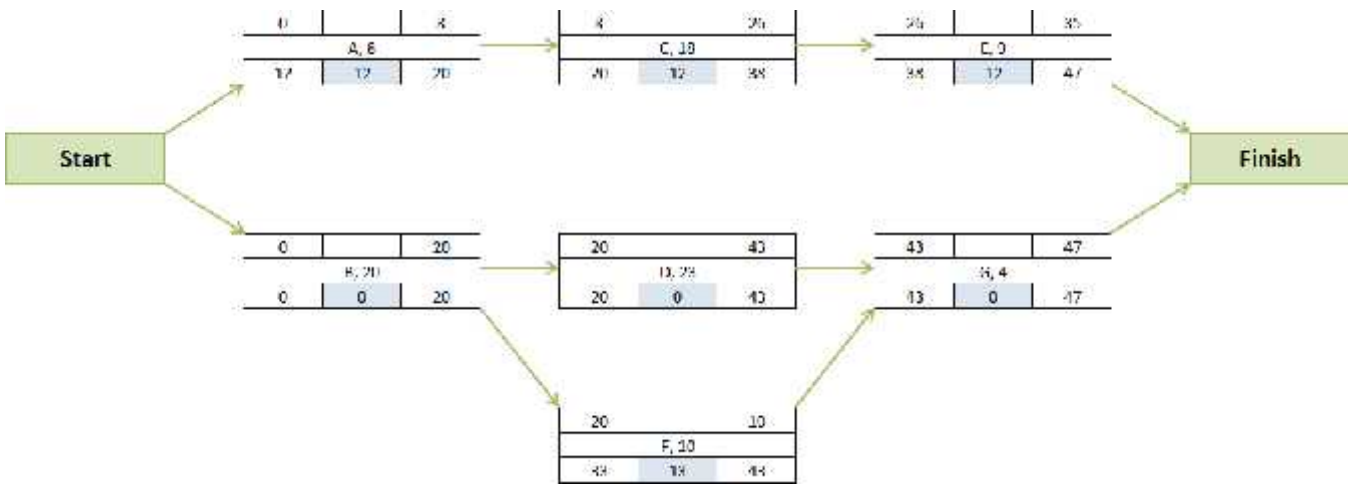

## Establish the Critical Path

Now that the amount of slack in each activity is identified, we can determine the critical path. The critical path is the path where there is no slack. It is important to identify the critical path on your network diagram, as this provides full visibility to everyone. You can identify via highlighting the nodes, inserting double-arrows, etc. In our example, the critical path is highlighted in red and is B, D, and G.

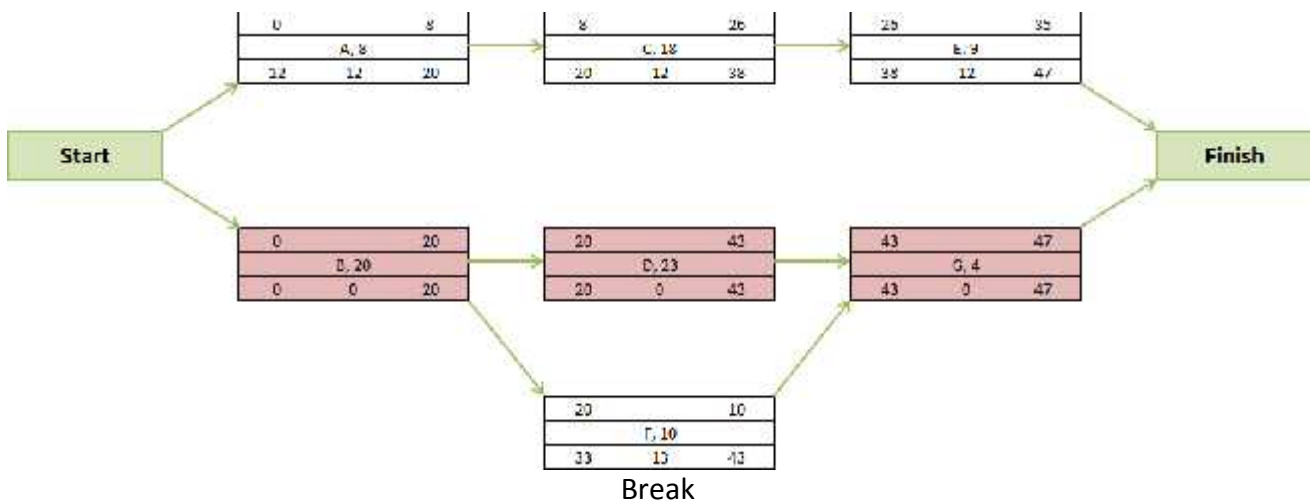

## Critical Path Exercise

Perform critical path analysis on the following example.

Task	Predecessor	Duration (days)
A	None	3
B	A	7
C	None	4
D	B	8
E	C	2
F	D	3
G	C, F	5

In the space below, draw the network diagram using the activity-on-node method.

### Program Evaluation and Review Technique (PERT)

#### PERT vs. CPM

PERT and CPM are identical in the way you create a network diagram, perform backward and forward passes, determine slack, and find the critical path. Why are there two methods? It's because they were created by two different people around the same time in the late 1950's.

The main difference between PERT and CPM is the way the activity estimation is performed. Rather than using one time estimate for each activity, PERT uses three. The three time estimates are: most likely time, optimistic time, and pessimistic time.

- Ñ **Most likely** time is the most common result when a task is completed multiple times in the same manner.
- Ñ **Optimistic** time is the shortest reasonable amount of time during which the activity can be completed if all goes as expected.
- Ñ **Pessimistic** time is the longest amount of time required to complete the activity, given that if anything can go wrong, it will.

PERT is valuable if there is a large portion of uncertainty in your project. It assumes that the uncertainty present in each of the three time estimates can be modeled by a probability distribution (the beta distribution).

## The PERT Formula

To combine the three estimates into one expected time estimate, the values must be plugged into a formula. The formula calculates the average estimated time ( $T_e$ ) to complete the task. The formula is written as follows:

$$T_e = \frac{T_o + 4T_m + T_p}{6}$$

Where:

$T_m$ = most likely time	$T_o$ = optimistic time
$T_p$ =pessimistic time	$T_e$ = expected (average) time

## Creating Time Estimates

The first step in using the PERT method starts during the estimation phase of the project. During this phase you assign the three time estimates to each activity. This will allow you use the formula above for PERT purposes and will provide you with a better idea of time durations for each task, when there is a great amount of uncertainty. Remember, you want to use the best estimates possible, so be sure to check with subject matter experts and your resource team when estimating.

## Test your knowledge

Perform PERT on the previously discussed Trip to New York project. Plug the values for  $T_o$ ,  $T_m$ , and  $T_p$  into the expected time formula above to get the value for  $T_e$ . (Time is represented in hours.)

Task No.	Task Name	$T_o$	$T_m$	$T_p$	$T_e$
A	Determine budget	1	4	8	
B	Select dates	1	2	6	
C	Renew passports	1	2	6	

D	Book flight	1	1	2	
E	Research hotels	2	4	6	
F	Book hotel	1	1	2	
G	Book car	1	1	2	
H	Plan activities	2	8	16	
I	Pack suitcases	1	2	4	
J	Go to airport	1	1	2	

### The Value of PERT

If there are a lot of questions surrounding tasks and milestones, or if the project is entirely new to you and your project team, it may be best to use PERT to determine the critical path, in which case you would need three estimates as opposed to one per activity. Knowing you are going to use the PERT method will help you avoid duplication of effort. Instead of creating one estimate in the beginning and then going back to create three estimates, simply knowing that you will perform PERT will set you on the right estimation path from the beginning.

### About Gantt Charts

Gantt charts are bar charts that provide a graphical representation of milestones, activities, and time. Once you know the estimated duration of your project, you should complete a Gantt chart. They are a valuable tool when scheduling work, allocating resources, and communicating project progress.

Although milestones have no standalone duration, it is common to add them to a Gantt chart for tracking purposes. Having milestones on your Gantt chart allows your project team and sponsor(s) to immediately focus in on and see high-level progress. In Microsoft Project, milestones are displayed as solid-colored diamonds. Here is a sample Gantt chart drawn by hand.

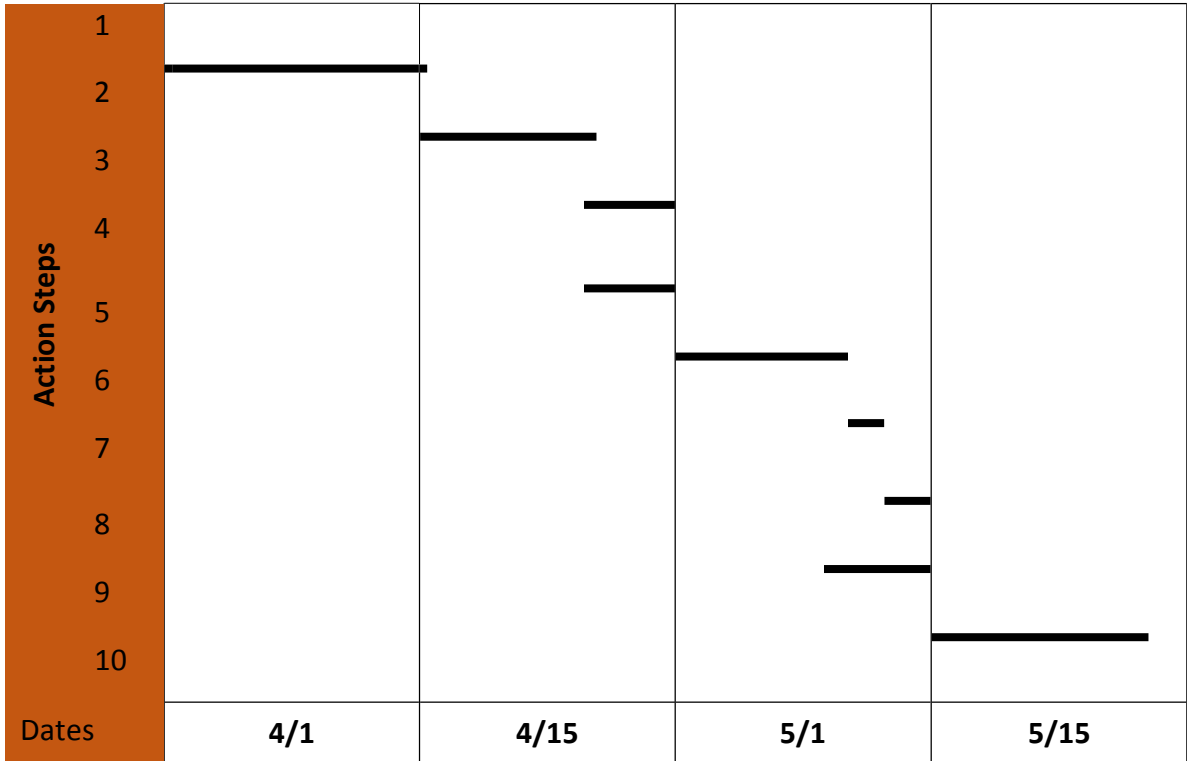

The image below is a simple Gantt chart created by a software program. Notice the milestone (diamond) in the image.

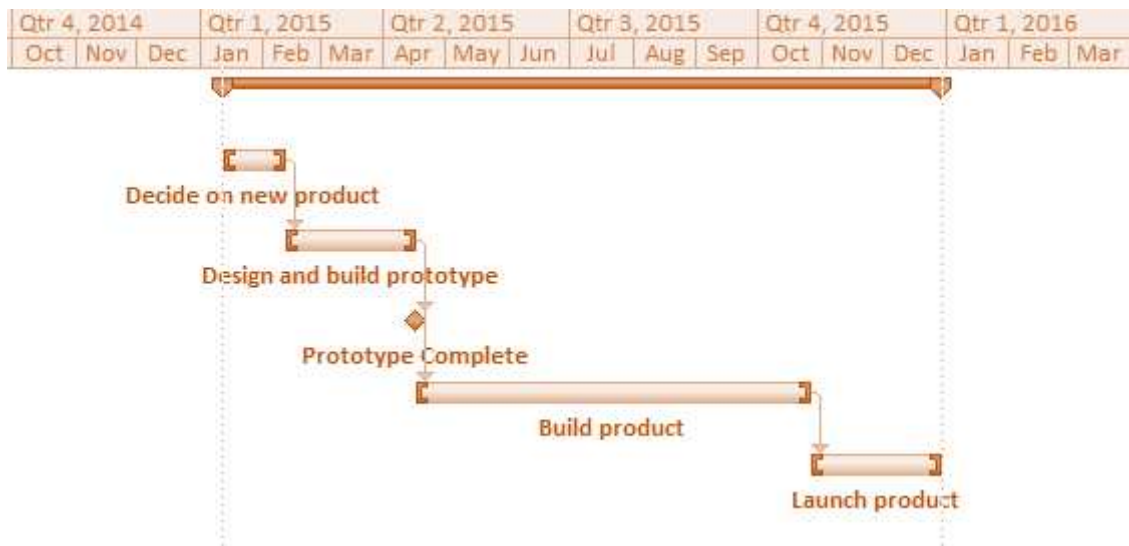

Computer-generated Gantt charts are capable of showing task relationships. This allows the project manager and resources to step through all of the project milestones and activities in order.

## Gantt Chart Exercise

Review the task relationships and durations in the table below. (Task durations are expressed in days.)

Task No.	Task Name	Depends On	Dependency (SS, FS, SF, FF)	T <sub>o</sub>	T <sub>m</sub>	T <sub>p</sub>	T <sub>e</sub>
A	Determine budget	N/A	N/A	1	4	8	4
B	Select dates	N/A	N/A	1	2	6	3
C	Renew passports	N/A	N/A	1	2	6	3
D	Book flight	Select dates	Finish-to-start	1	1	2	1
E	Research hotels	N/A	Finish-to-start	2	4	6	4
F	Book hotel	Research hotels	Finish-to-start	1	1	2	1
G	Book car	Book flight	Finish-to-start	1	1	2	1
H	Plan activities	Book flight	Finish-to-start	2	8	16	8
I	Pack suitcases	Book flight	Finish-to-start	1	2	4	2
J	Go to airport	Pack suitcases	Finish-to-start	1	1	2	1

Draw a Gantt chart that depicts the task relationships and the durations.

A							
B							
C							
D							
E							
F							
G							
H							
I							
J							
<b>Dates</b>	<b>1</b>	<b>5</b>	<b>10</b>	<b>15</b>	<b>20</b>	<b>25</b>	<b>30</b>

## Scheduling Software

When creating a schedule, the size of your project tends to dictate the software required. If the project is small and manageable, an Excel spreadsheet will likely suffice for creating the schedule, tracking action items and deliverables, and for managing resources. If the project is large, you may need more formal software such as Microsoft Project, Open Workbench (freeware), Agile, Clarion, etc.

### How do you know what software is best for you?

Does your company have a preferred scheduling software program? If so, there could be a spare license floating around, or an additional license may need to be purchased. If there is no preferred program, it is at the discretion of the project manager.

When you are using a new piece of software, you should receive some form of training (in class, online, or in a book) before delving into using the program. It takes times to understand how to properly enter tasks, assign resources, and create dependencies.

As previously mentioned, a Gantt chart provides a graphical representation of activities. Gantt charts can be created by hand in Microsoft Word and Excel, or automatically in specialized programs like Microsoft Project and other scheduling software. Activities, duration estimates, and task relationships come together to form the Gantt charts in software applications.

Below is a Gantt chart as displayed in Open Workbench.

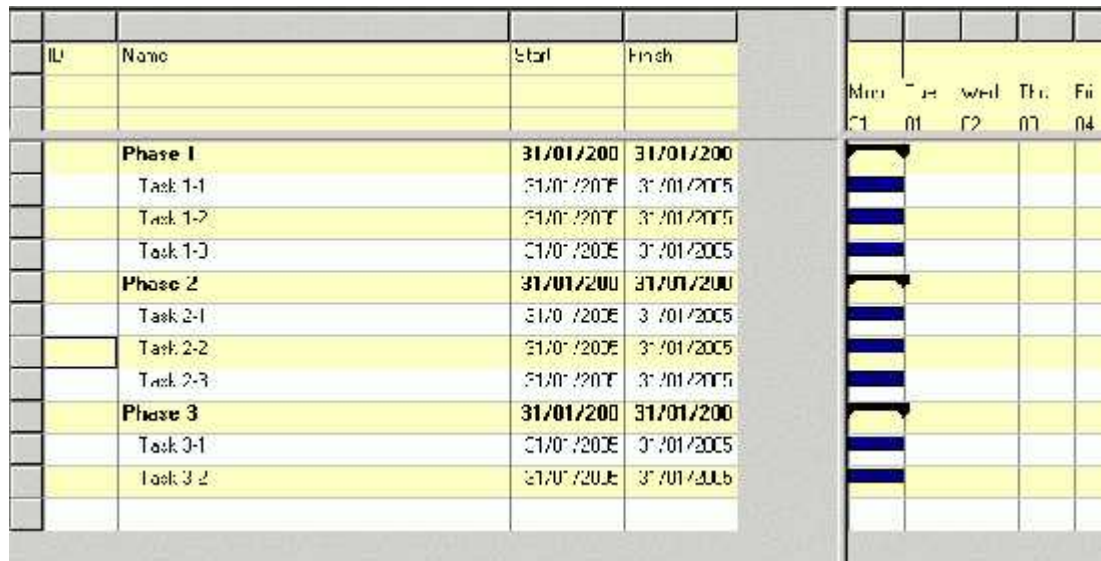

Below is a Gantt chart as displayed in Microsoft Project.

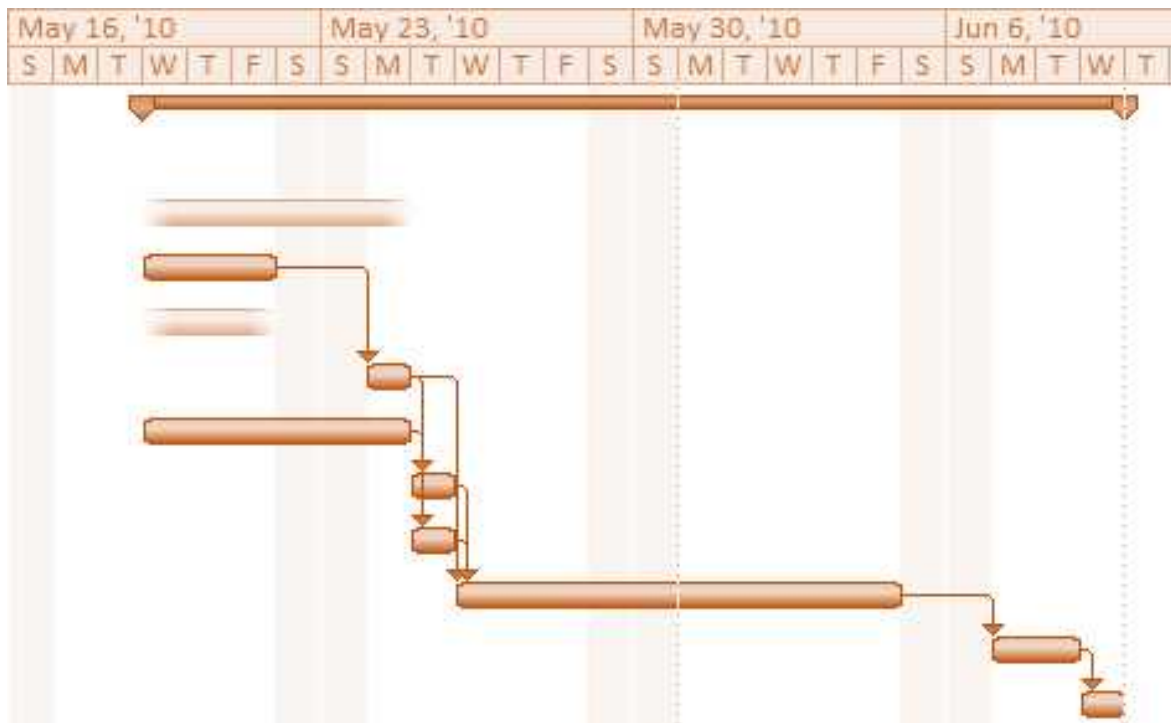

As you can see, Gantt charts between software programs are similar. They all require the input of tasks, task durations, task relationships, resources, and working time/days.



## Risk Management Planning

### Process Overview

Creating a risk management plan allows you to have a contingent response strategy for anticipated risks. A risk management plan should identify the risk, quantify the risk, discuss the response strategy, and discuss the risk monitoring plan. This plan will help you identify risks earlier and will allow you to get your solution implemented much faster than if the risk was unidentified.

There are four stages to risk management planning:



### Identification of Risk

Identifying the risk should detail the risk, its trigger event/point, and its potential impact on the project. For example, the risk of not receiving vendor information on time will result in the project not being completed on time. For every day the vendor information is not received, one day will be added onto the completion date of the project.

Knowing what the trigger event is and when it could happen will allow you to look at your critical path to determine if slack exists in the task. If slack exists, is there ample time to initiate and execute the back-up plan? If not, what is your prediction on how the schedule will be affected by the risk (i.e. pushed out, unable to finish, etc.)?

### Quantification of Risk

Quantification of risk needs to be assessed. Look at the impact of the risk and the likelihood that the risk will happen (i.e. the probability). On a scale of low (1), medium (2), high (3), or critical (4), quantify the overall risk and its effect on the project. This assessment is easier to visualize through the use of a priority matrix.

Probability	4	Medium		Critical	
	3				
	2	Low		High	
	1				
		1	2	3	4
		Impact			

For example, if a risk has a high probability (3) and a low impact (2), the overall risk is considered medium priority.

### Responding to Risk

The response strategy for risk is where you determine what the risk trigger will be and how you will respond to the risk. There are four strategies to handle negative risk: avoid, transfer, mitigate, and do nothing.

**Risk avoidance** involves avoiding the risk altogether. You could change the project plan to eliminate the risk by reducing the scope of the project. Let's say you're planning an outdoor party and weather is a concern. You could plan to have the party inside to avoid the problem entirely.

**Transference of risk** usually includes a third-party insurance policy that will compensate if things go awry.

**Risk mitigation** is an attempt to reduce the impact or probability of the risk. In the example above you could mitigate the risk by putting umbrellas up.

**The "do nothing" approach** means that you've identified a potential risk, are aware that it could happen, but choose to do nothing about it. Instead you wait to see if the risk happens, and if it does you deal with it by whatever means necessary. This approach might be okay for very small projects or risks with low priority, but for projects with tight timelines, this approach isn't recommended.

### Monitoring and Controlling Risk

The key to controlling risks is to monitor your risk register on a regular basis. You can hold regular meetings to discuss changes to risks or potential trigger events that you or team members have seen. Keeping the team involved with identifying and controlling risks will help them better identify risks at their onset.

The risk management plan is a document that you should share with your project team and project sponsor. It will provide insight for everyone on what could go wrong at any point during the project. This knowledge will help your team be aware of and potentially identify risks more easily, should they occur.

Think about the project of planning an outdoor surprise barbeque party for your spouse's birthday.

- Ñ What happens if it rains?
- Ñ What happens if your barbeque runs out of propane?
- Ñ What happens if it suddenly cools off outside and everyone is freezing?

Each of these questions identifies a potential risk to your project. How you choose to address and respond to the risk depends on how well you anticipated the risk.

You will be unable to predict everything that could and will go wrong with a project. However, knowing and understanding the overall project timeline and documenting contingency plans is a huge step in the right direction. Also, being in tune with your schedule, anticipating when/where risks could creep into your project, and where slack exists in the schedule, will help turn things around quickly if they do go wrong.

### Pre-Assignment Review

You were asked to come to this workshop with an idea for a project you have been assigned to do or would like to do (either at work or at home). Take ten minutes to think about all of the potential risks associated with the project. Then, fill out the Risk Register below, detailing all of the potential risks surrounding your project, regardless of whether the scope is well defined or not. Complete the fields the best you can.

Risk Description	Trigger	Probability	Impact	Response

## Communication Strategies

### About Communication

Communication is the single most important part of a project. How would projects ever progress if there was no communication between sponsors, project managers, team members, customers, and suppliers? What would you do if you had a question and there was no one to ask for help? The project would come to a grinding halt once progress ceased.

To help overcome obstacles and eliminate surprises during the progression of a project, a key piece of documentation, called a communication plan, needs to be created. Communication plans are typically generated at the onset of a project.

Communication plans can be as simple as a spreadsheet, or as complicated as a formal document. The plan outlines who will receive updates, how often updates will be provided, the medium (e-mail, presentation, etc.) through which updates will be communicated, the frequency of team meetings, and the format of all communications.

The communication plan sets up expectations for communication. Confidence is instilled in people, from team members to project sponsors, when they know what to expect.

All types of communication activity should have the following information:

- Ñ Purpose
- Ñ Information Required
- Ñ Frequency
- Ñ Method

### Purpose

There should always be a reason for each communication. The following four categories describe solid reasons for communication.

### Updates

Updates provide information on project progress to project sponsors, stakeholders, or project team members. Updates can sometimes involve scope refinements or additions, or decisions made by the project manager, sponsor, or steering committee.

### Seek approval

As projects evolve, it's often necessary to change the scope of the project. Before any project-altering decisions are made, the project manager should seek approval from the project sponsor.

**Review**

Reviews take place for a number of reasons. As a project progresses, it's important to review decisions made, action items completed, meeting minutes, risk plans, etc.

**General**

Communication that doesn't fall into the above three categories can fall under the "general" umbrella. Perhaps you have a new project team member you want to introduce to the group. Maybe you touch base with your team once a month to discuss open issues or to table new issues. Whatever the reason, it's important to always keep the lines of communication open.

**Information Required**

Not everyone involved with a project needs to know every detail of what's happening. It's important for the project manager to understand each person's role and the extent to which they need (or want) to be involved.

**Frequency**

Determining the frequency of communication typically depends on the role people hold on a project. While a project sponsor needs to be kept abreast of the major happenings (typically at least once a month), team members need to meet regularly to keep project continuity going.

**Method**

There are various communication methods that you can use, from verbal to written to electronic. Choose the method that best suits your audience and your timeline. Below is a list of different modes of communicating.

Type/Technique	Description
E-mail	Allows project teams to share text, audio, and video files between team members.
Interoffice Memos	Provides a formal forum to communicate key dates, policies, and procedures.
Instant Messaging (IM)	Allows team members to communicate real-time.
Meetings	Provides a means for regular status updates, project reviews, etc. Meetings are more formal than an e-mail or a phone call and should be followed by minute distribution.

Telephone/Video Conferences	Provides a medium to involve team members located in other regions.
Intranet, Internet Boards, SharePoint sites	Formally communicates status, progress, highlights, and objectives to all.
Walk-About	Involves a hands-on, face-to-face approach with your team and clients.

**Tips for Successful Communication**

Keep a running list of assumptions and of decisions made. This will save time in the long run when people ask why did we do it this way, or why did you estimate five hours for a task that will likely take half that long?

Always take minutes at high-level meetings and send out to all meeting attendees within two days of the meeting. Otherwise, the knowledge and decisions made in the meeting could be forgotten.

Below is a communication plan layout in Excel.

Communication Plan						
Project			Project #			
Project manager			Sponsor			
Project artifacts			Updated			
ID	Communication	Description	Frequency	Format	Owner	Recipient/Attendees
1	What type of communication is this?	What is the description of the contents/purpose of this communication?			Who sends?	Who gets?
2						
3						
4						
5						
6						
7						
8						
9						
10						

**Team Members**

**Project Sponsor**

The project sponsor is the individual or organization for whom the project is completed. The sponsor finances the project and is the most important stakeholder. It is possible to have more than one sponsor

for a project. Sponsors can represent different functions and departments, yet they must each be equally informed about project progress.

### **Purpose**

The project sponsor(s) need to receive communication for information, decision making, issue resolution, and approval purposes. Since the sponsor is the driving force behind the project, they need to be involved with the high-level decisions and all major project change approvals.

### **Information Required**

Project sponsors need to be kept informed of all project happenings. Topics should include project health, milestone achievements, critical issue discussion, approval of project scope changes, and critical path/timeline updates. They should also receive status reports.

### **Frequency**

The project manager should meet with and update the project sponsor(s) frequently. Depending on the role that the sponsor assumes with the project, regularly scheduled updates can take place weekly, bi-weekly, or monthly. Critical issue discussion/resolution and approvals for changes to the project plan should happen as required.

### **Method**

Sponsors tend to receive formal updates in meetings with the project manager. Although meetings happen with the sponsor on a regular basis, it's sometimes necessary to send information, updates, or questions in between meetings.

### **Project Stakeholders**

Stakeholders are individuals or organizations that are not directly involved with a project, but who have an interest in its outcome.

### **Purpose**

Project stakeholders receive communication for information purposes. Because they have an interest in the project outcome, they care about the success of the project.

### **Information Required**

Stakeholders typically like to see status reports that address project health, milestones achieved, significant changes to the scope of the project, and updates on changes to the critical path and/or project timelines. If you are unsure about the type of information your stakeholders would like to see, ask. Stakeholders might request additional information and reports throughout the project; it is in your best interest to provide them with everything they ask for.

### **Frequency**

Monthly updates usually work well for mid/large-size projects, but it is up to you and the stakeholders to determine the best frequency.

### **Method**

Stakeholders will usually let you know via the project sponsor how they want to receive updates. Depending on your organization and stakeholder preference, you could be asked to hold a meeting, to facilitate a conference call, or to send an e-mail with a status report or presentation attached.

### **Project Team**

The project team is a group of individuals who work together towards the common goal of project completion. Whether they're on the project part-time or full-time, they all need to keep abreast of project information, decisions, and updates.

How do we do this?

- Ñ Stress the importance of talking about their problems as they arise to the team
- Ñ Provide meeting minutes
- Ñ Distribute updated schedule as required

### **Purpose**

Project team members receive communication because as decisions are made or need to be made, project plans change. As well, team members will need to discuss issues and concerns as their daily tasks can be directly affected. Communicating with the project team will also foster good working relationships and encourage ongoing communication.

### **Information Required**

Team members need to be updated on changes in project scope, timelines, milestone accomplishments, and decisions made. They need to receive all information that could result in changes to any of their tasks, assignments, or action items. The team also needs to get together to discuss outstanding issues and to resolve issues and answer questions as they arise.

### **Frequency**

Informal communication amongst team members can happen daily, while formal communication should happen every week. Weekly sessions allow the project manager to formally record and track action items, tasks, and issues with all team members.

### **Method**

Informal communication between team members can happen via e-mail, conversations in cubicles, phone calls, etc. Formal communication from the project manager should happen in weekly or impromptu meetings.

### **Other Special Target Groups/End Users**

Other groups can include special target groups and end users. Follow these guidelines when communicating with special groups.

#### **Purpose**

You will want to communicate formally or informally with people who are not directly involved with a project, but who are affected by a project during the implementation phase or after. For example, customer service personnel are not directly involved with the launch of new services. However, once the service is launched, the customer service reps are responsible for taking customer phone calls and must be prepared to answer customer questions. In this case, communication in the form of training is required for the customer service representatives.

#### **Type of Information**

These groups should be informed of major milestone completions, general project updates, training, and the project's status.

#### **Frequency**

Communication with target groups happens as needed during the project or as the project draws closer to completion.

#### **Method**

The following methods work best for communicating with these groups: lunch and learns, training, announcements, intranet updates, and presentations.

### **Cross-Functional Teams**

When there are cross-functional teams on a project, it's up to each department representative to take messages, timelines, and pertinent information back to their managers and supervisors. This is particularly important where time delays could affect the work of other departments.

### **Communication Exercise**

**Fill in the communication below for your pre-assignment project.** It should detail several key pieces of communication that need to happen, the person who needs to receive the communication, the frequency of the communication, and the method of communication.

What	Who/Target	Purpose	Frequency	Method(s)

## Creating a Viable Schedule

### Creating a Schedule

Each of the previous topics we discussed come together in this section to create a workable schedule. To recap, the steps involved in creating a viable schedule are:



**Common Scheduling Problems**

Come up with some solutions for each of the following scheduling problems.

**Unacceptable completion date**

---

---

---

---

---

---

---

---

**Unrealistic deadlines**

---

---

---

---

---

---

---

---

---

---

**Unforeseen problems**

---

---

---

---

---

---

---

---

---

---

**Passive project execution**

---

---

---

---

---

---

---

---

---

---

**Poor scheduling**

---

---

---

---

---

---

---

---

---

**No project closeout**

---

---

---

---

---

---

---

---

---

---

## Updating and Monitoring the Schedule

### Schedule Updates

As a project progresses, the schedule will need to be updated. Throughout projects, resources will leave, new people will join, issues will arise, and contingency plans could very well need to be put into action. Because of this ever-changing chain of events, the schedule should be updated regularly.

### Frequency of Updates

Although weekly team meetings are recommended for most projects, the project manager will determine the optimal frequency for their project. Whether you have weekly, bi-weekly, or monthly meetings, the schedule should be updated and sent out with the meeting minutes and list of action items.

### Receiving Updates

Ask task owners or project members to come to the regular team meetings prepared to provide schedule updates. Updates should include task completion, issues they are working through, and anything else that could be pertinent. This reminds the scheduler to update the schedule and it ensures everyone is being held accountable for their assigned tasks.

The first few updates will take a while to accomplish as people become familiar with their tasks, roles, and the update process. As more updates are completed in the weekly meetings, the process of updating the schedule will become routine for the task owners.

When a schedule is kept up to date, it serves as the focal point for project progress. If tasks are being completed on time, and resources are working tasks according to the developed timelines, the schedule is accurate.

A solid schedule helps the project manager manage the project according to time and budget. If the timeline begins to slip, it is almost certain that the cost of the project is going to increase.

### **Format for Updates**

After a schedule is updated, or according to a pre-determined delivery time, team members need to receive updated copies of the schedule. The updates should include information about tasks that are in progress, new tasks that have been added, tasks that are due in the next two weeks to one month, and tasks that are past due. The updates should also include information about updates to milestones (i.e. ahead of schedule or pushed out), and any decisions that were made that resulted in a change to the schedule.

The schedule should be kept in a common project folder for all to view. In order to maintain the integrity of the schedule, only one person should be responsible for performing schedule updates.

### **Better Predicting**

Updating a schedule regularly provides the project manager and all team members insight into how long each task took in comparison to the estimated time. This knowledge could help all project members on future projects when attempting to estimate task durations and to break down high-level activities.

### **Schedule Monitoring**

Once the schedule is created and updates are happening according to plan, the only thing left to do is identify the potential risks associated with the project and create a risk management plan. Periodic monitoring of the plan will ensure you keep on top of the issues that could arise, and will allow you to quickly realize the issue once the trigger/event for the risk has been realized.

Most projects do not go as planned. That said, if a project's schedule is accurate, detailed, and on task, it will be much easier to control project variances. The statement of work and the project scope document should be referred to throughout the life cycle of the project to prevent scope creep (uncontrolled project changes).

### **Case Study**

#### **Situation**

Consider the project of implementing a quality monitoring software program into a call center (“...your call may be recorded for quality monitoring purposes”). You have a schedule that you are following when

suddenly, three days after the installation of the new server, the entire computer system crashes. This server crash cripples project progress, as nothing can proceed until a new server is received and installed. The lead time for a new server and an installer is six weeks.

**Questions**

**What do you do?**

---

---

---

---

---

---

---

---

**What are the issues with which you are now faced?**

---

---

---

---

---

---

---

---

**To whom do you send a communication?**

---

---

---

---

---

---

---

---

**What is the message?**

---

---

---

---

---

---

---

---

---

---

**What is the delivery method?**

---

---

---

---

---

---

---

---

---

---

### Further Reading:

- ✓ Lewis, James P. *Project Planning, Scheduling, and Control (5th Edition)*. McGraw-Hill, 2010.
- ✓ Mintzer, Richard. *The Everything Project Management Book (2nd Edition)*. Adams Media Corporation, 2008.
- ✓ Project Management Institute. *A Guide to the Project Management Body of Knowledge (5th Edition)*. Project Management Institute, 2013.